



ATP+ADP+AMP hygiene monitoring test kit (For water and liquid sample)

LuciPac™ A3 Water Instruction Manual

Product code:60365



CAUTION !

1. Do not attempt to drink the kit reagent, touch it with bare hands or allow it to splash into eyes.
2. Please make sure to read the precautions and instructions in this Instruction Manual before attempting to use the kit and exercise extreme caution when using it.

LuciPac A3 Water is a kit for testing cleanliness levels of water and other liquid samples using bioluminescence techniques with firefly luciferase developed with Kikkoman's unique biotechnology.

[Applications]

This kit can be used to test cleanliness levels of water and other liquid samples.

Do not use this device for any purpose other than what it was designed for as a tester of cleanliness levels. Please be aware that this kit cannot be used to test or measure for viable bacteria counts levels or more specific types of pathogenic bacteria.

This kit shall not provide any guaranty that a given test sample is free of bacterial contamination. This kit is not suitable for microbial testing of originally ATP rich beverages, such as fruit juices.

[Measurement Principles]

This kit uses an enzyme cycling method based on a combination of luminescent reactions from firefly luciferase, pyruvate, orthophosphate dikinase (PPDK) and pyruvate kinase (PK). This method produces a given amount of luminescent that is proportional to the amounts of adenosine triphosphate (ATP), adenosine diphosphate (ADP) and adenosine monophosphate (AMP) present.

ATP is a source of energy necessary for various forms of life that are present in organic residues, such as microorganisms, food residue, and biological substances that originate from other living organisms. This ATP monitoring system allows you to measure and detect organic residues at high speed and high sensitivity by detecting ATP using luciferase, which is why it is widely used in determining cleanliness levels in food manufacturing site and medical treatment facilities. However, conventional ATP monitoring system is insufficient because ADP and AMP generated from ATP degradation are completely overlooked. Kikkoman succeeded in developing a new ATP + ADP + AMP

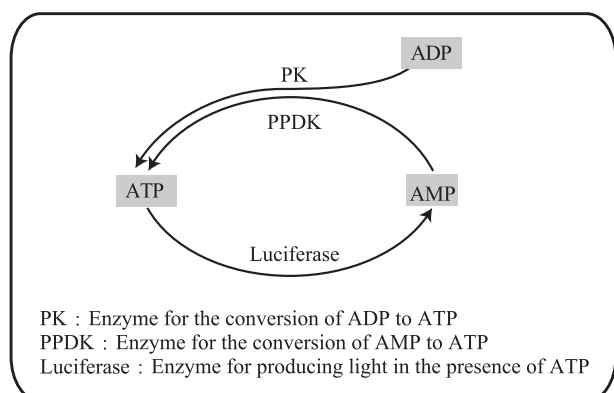

Fig. 1: Principle of luminescence method using the enzyme cycling

monitoring system as shown in Fig. 1. This method definitely enables high sensitive analyses of a wider range of organic residues.

[Contents]

The LuciPac A3 Water kit contains five aluminum bags, each containing 20 sampling devices (for a total of 100 sampling devices). This kit is a simple integrated testing instrument that contains both the test reagent and the sampling stick required for testing cleanliness levels of water and other liquid samples.

Table 1: Main components of each reagent

Reagent name	Main component
Luminescent reagent	Luciferin Luciferase Magnesium acetate Phosphoenolpyruvic acid Pyrophosphoric acid Pyruvate, orthophosphate dikinase Pyruvate kinase
Releasing reagent	Surfactant (Benzalkonium chloride)

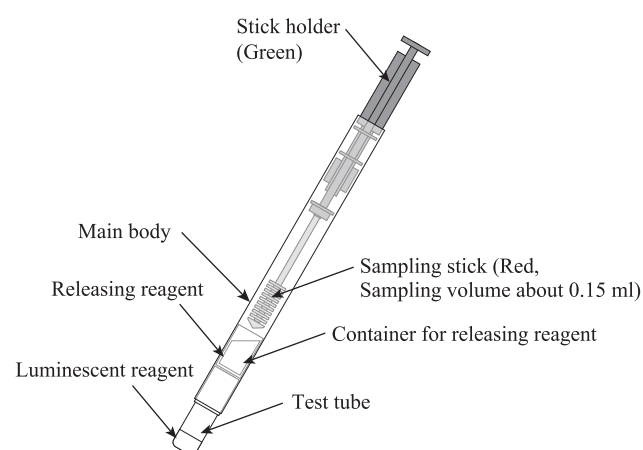

Fig. 2: The name of each part of the LuciPac A3 Water

[Precautions for Use]

Please make sure to follow the precautions listed below in order to obtain optimal performance from this kit.

- ① Do not use products that are past the expiry date. Expired products may not yield accurate results (the expiry date is printed on the label of the aluminum bag holding the sampling devices).

- ② Be sure to use only designated products when taking measurements for amounts of luminescence. This kit cannot be used with nondesignated products.
- ③ The swab devices should be allowed to reach room temperature (see Table 2) prior to testing, if they are from refrigerated stock. Measurement values may read lower than actual if the sampling devices are used while still cold. Use the sampling devices as soon as possible once they have returned to room temperature. Do not let the kit sit out in temperatures exceeding 35°C (95°F). High temperatures may cause product performance to drop.

Table 2: Appropriate measurement temperature

Model	Temperature compensation setting	Temperature range
Lumitester PD-20	—	20 - 35°C (68 - 95°F)
Lumitester PD-30	OFF	
		ON*1)

*1) Temperature compensation is performed in accordance with the measured value of a thermometer incorporated in the main body of Lumitester PD-30. Consequently, the compensation cannot be performed precisely if the temperature of the main body of PD-30 is different from LuciPa. Please be sure that temperatures of the main body of PD-30 and LuciPac become equal before use.

- ④ Wherever possible, be sure to use up all sampling devices from a single bag that has been opened at one time. If it's necessary to store leftover sampling devices once finished with a test session, firmly close the aluminum bag and store it in a refrigerated environment (2°C to 8°C (35.6°F to 46.4°F)). High temperatures may cause product performance to drop.
- ⑤ Do not subject the kit or any part of it to direct sunlight for long periods of time. Strong light may cause product performance to drop.
- ⑥ Do not touch any of the parts inside the sampling devices, particularly not any part of the sampling stick itself, with a finger or other object before use. Touching the parts may affect cleanliness levels, making them hard to determine.
- ⑦ Do not drop the kit or any of its parts or allow any parts to be struck or jolted. The inner aluminum sheets and other parts in the kit may become damaged, causing product performance to drop.
- ⑧ Do not use the kit if any parts become damaged such as the inner aluminum sheets. Such damage may affect product performance, causing cleanliness levels to fail to be measured correctly. You can tell if the aluminum sheet is damaged or not by checking to see if the releasing reagent is leaking.
- ⑨ Do not soak more than 3 cm from the tip of the sampling stick into water or other liquid samples. The water or other liquid samples which wet the shaft of the sampling stick may affect test results.
- ⑩ Secure the test tube of the LuciPac to ensure that it does not become shifted or displaced. It may be difficult to accurately determine cleanliness levels if the test reagent begins leaking because the tube has been shifted. It may become difficult to remove the LuciPac from the measurement device once the measurements have been taken. Moreover, it may cause malfunction of the measurement device.

[Designated Product for Measurement]

Lumitester PD-20 and Lumitester PD-30

(Manufacturer: Kikkoman Biochemifa Company)

Be sure to use only designated products when taking measurements.

[Measurement Methods]

1. Measurement procedures

Complete the procedures listed below within the appropriate temperature range as shown in Table 2 depending on the instrument used and the temperature compensation setting. Make sure to always run measurement tests at the same temperature to maintain repeatability from comparison, if the temperature compensation is not used. Get the LuciPac out of the refrigerator, and wait until they have reached room temperature (see Table 2). Use the sampling devices as soon as possible once they have returned to room temperature.

- ① Remove the sampling stick from the main body (casing).
- ② Soak sampling stick about 3 cm from the tip of the sampling stick into water or other liquid samples, and shake it gently. Make sure any bubble don't remain in the comb of the sampling stick.
- ③ Pull out the sampling stick slowly and straight up from the sample.
- ④ Return the sampling stick to the the main body (casing) and push it all the way into the the main body (casing).
- ⑤ Hold the LuciPac casing firmly and shake it.
- ⑥ Allow the leftover luminescent reagent to thoroughly dissolve.
- ⑦ Insert the LuciPac into the Lumitester to measure the results.

2. Handling of data

Normal / defect criteria should be decided by user based on observation of data for certain period of time under normal operation in consideration with fluctuation of the data. In addition, if possible, the artificial inadequate cleaning conditions or artificially contaminated conditions should be evaluated.

[Disposal Methods]

This kit contains no hazardous materials. This kit can be disposed of as regular garbage, but when disposing of it, it would be better to separate the parts and dispose of each one properly in accordance with the local regulations outlined by the local governments for proper disposal of waste materials.

The main materials and parts used in this kit are listed below. No PVC materials are used in the making of the plastics in this kit.

Table 4: Main raw materials of the structural parts of this product

Structural parts	Raw materials
Swab stick (green part)	Polypropylene
Main body (casing)	Polypropylene
Sampling stick (red part)	ABS resin
Container for releasing reagent	Polypropylene, Aluminum
Measurement tube	Polypropylene, Aluminum
Aluminum bag (with dehumidifying function)	Aluminum, Polyethylene, Polyethylene terephthalate
Outer bag	Polyethylene

[Precautions for Handling]

- ① Be careful not to let the reagents or other substances in the kit get into your mouth or eyes, or onto bare hands before or after use. Rinse your mouth out thoroughly with water if any of the substances get into your mouth, rinse off your skin with copious amounts of water if any get onto your skin, and rinse out affected eyes thoroughly with copious amounts of water

should it get into your eyes. Immediately contact a physician for advice and follow the instructions given.

- ② Exercise enough caution when storing and disposing of the kit and its reagents to ensure that none of the substances become mixed in with food and other products.
- ③ Be careful not to get fingers caught when inserting the sampling stick into the main body (casing).
- ④ Please make sure to store this kit and its parts out of the reach of young children.
- ⑤ Note that the releasing reagent used in this kit contains cationic surfactants (benzalkonium chloride*2). Take precautions when disposing of this kit after use to ensure that such substances do not become mixed in with food products at food production centers and similar facilities.







*2) Benzalkonium chloride is a disinfectant and antiseptic commonly used in hand and finger sterilizer solutions.

[Storage]

- 1) Kit storage: Kits are to be stored at a low temperature (2°C to 8°C (35.6°F to 46.4°F)) for long term storage. The kit can be stored below 25°C (77°F) for up to 14 days or below 30°C (86°F) for up to 5 days before opening an aluminum bag without any adverse effect on the long term stability. Do not freeze the kit.
- 2) We recommend that you use all 20 sampling devices in a single bag at one time after opening an aluminum bag. If you have leftover sampling devices that you must store after opening a bag, be sure to store them at the recommended low temperature (2°C to 8°C (35.6°F to 46.4°F)) and use them within two weeks from when the bag is opened.
- 3) Expiry date: Printed on the aluminum bag.

[Warranty]

Kikkoman Biochemifa Company warrants the products in this kit to have a certain level of quality. This warranty guarantees that Kikkoman Biochemifa Company shall replace defective products should any be found. This warranty does not provide any other guarantees. Kikkoman Biochemifa Company shall not be liable for any damages, including special or consequential damages, or expenses arising directly or indirectly from the use of this product.

Symbols Used in the Packaging and Labeling of this product	
	Symbol for "temperature limitation." The upper and lower temperature limits will be indicated on either side of the symbol. Please store this product at the indicated temperature range.
	Symbol for "Caution" or "Attention" for use.
	Symbol for "Lot Number." This symbol shall be adjacent to the manufacturer's lot number (e.g. 20170410W) or description of its printed location.
	Symbol for "Use By." This symbol shall be adjacent to the expiration date, expressed as YYYYMMDD (e.g. 20180709), or description of its printed location.
	Symbol for "Consult Instructions Manual."
	Symbol for "Manufacturer." This symbol shall be adjacent to the name and address of the manufacturer.

"LuciPac" and "Lumitester" are registered trademarks of Kikkoman Corporation in Japan and other countries.

Manufacturer:

Kikkoman Biochemifa Company

2-1-1 Nishi-shinbashi, Minato-ku, Tokyo 105-0003, Japan
 Phone: +81-3-5521-5492 / Fax: +81-3-5521-5498
 E-mail: biochemifa@mail.kikkoman.co.jp
 URL: <http://biochemifa.kikkoman.co.jp/e/>

[Directions for LuciPac A3 Water]

<Leave “LuciPac” at room temperature (see Table 2) until they have reached room temperature. >

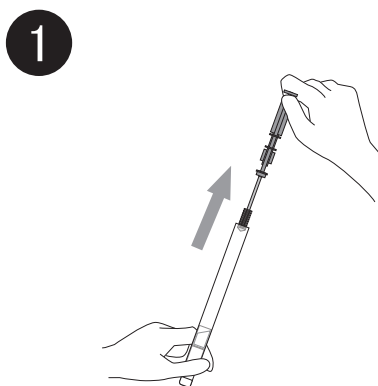
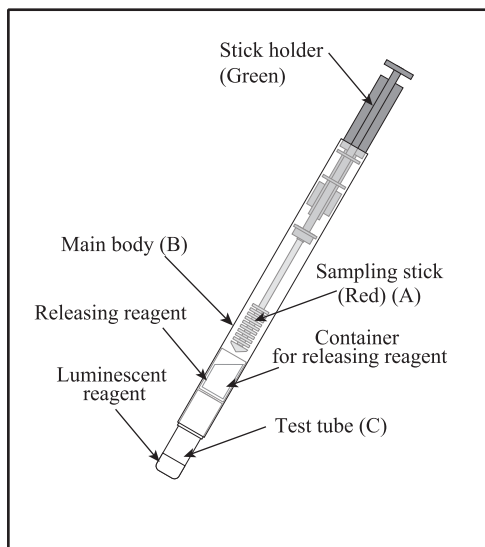

1 Pull the sampling stick (A) out of the main body (B). (Be careful not to touch the sampling stick)

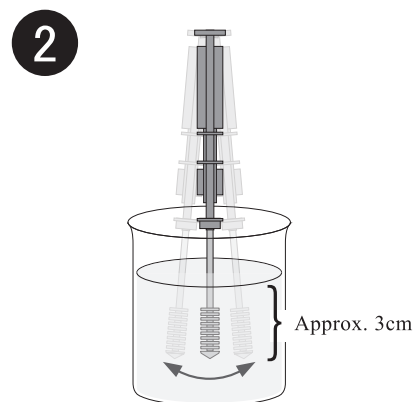

2 Soak sampling stick into water or other liquid samples, and shake it gently. Make sure any bubble don't remain in the comb of the sampling stick.

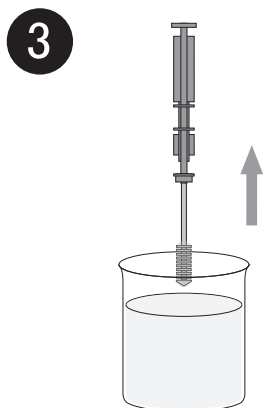

3 Pull out the sampling stick slowly and straight up from the sample.

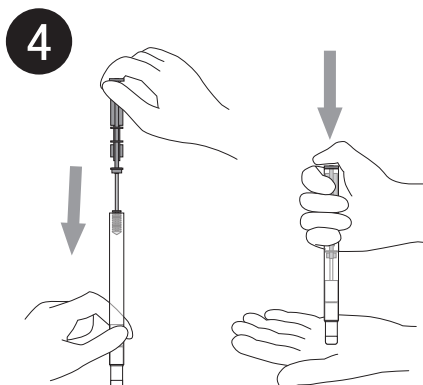

4 Put the sampling stick (A) back into the main body (B) and push it through all the way by putting the tip of the test tube (C) on the palm of a hand or on a table. (Be careful not to get fingers caught when pushing it.)

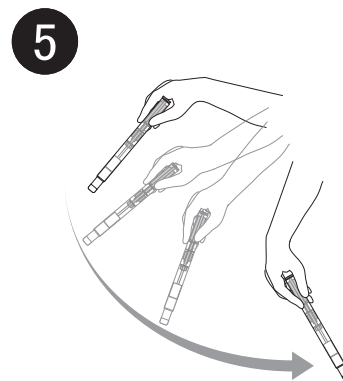

5 Shake the whole body of the LuciPac a few times so that the liquid in the capsule falls into the test tube (C).

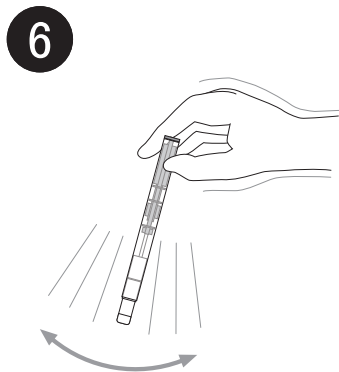

6 Gently shake the whole body of the LuciPac so that the luminescent reagent is entirely dissolved.



7 Insert the whole body of the LuciPac into the measurement chamber of the Lumiester. Then, close the chamber cover.



8 Press the "ENTER" key. Results are obtained in 10 seconds.